

KAUFHAUS

DEPARTMENT STORE
MAGASIN D'ALLIMENTATION
WARENHUIS



Art. Nr. 194920

D

Vor Beginn des Bastelns sollten Sie sich mit den Spritzlingen und der Anleitung vertraut machen. Sollte es einmal vorkommen, dass ein Teil im Bausatz fehlt, kreuzen Sie bitte das fehlende Teil in der Anleitung an und schicken Sie diese bitte an Fa. Gebr. FALLER GmbH, Abt. Kundendienst, kundendienst@faller.de, Kreuzstraße 9, 78148 Gütenbach. Sie erhalten dann umgehend Ersatz. In diesem Bausatz sind einige Kunststoffteile übrig.

GB

Before beginning with the assembly please familiarize yourself with the parts and read the instructions carefully. In case of missing parts please indicate these on the instructions leaflet with a circle and return the leaflet to Gebr. FALLER GmbH, kundendienst@faller.de, Kreuzstraße 9, D-78148 Gütenbach, Germany. You will receive the replacement by return. Some of the parts in this box are not needed to construct the model.

F

Avant de commencer le montage de votre maquette bien lire la notice et repérer les grappes. Si une pièce manque dans une boîte, cochez la pièce correspondante sur la notice et renvoyez-la-nous à Gebr. FALLER GmbH, kundendienst@faller.de, Kreuzstraße 9, D-78148 Gütenbach (R.F.A.). Nous vous ferons parvenir la pièce par retour. Dans cette boîte se trouvent quelques pièces qui ne seront pas utilisées pour le montage.

NL

Vóór het bouwen zou men de gielstukken en de handleiding moeten bestuderen. Indien onverhoopt een onderdeel aan het bouwpakket ontbreekt, gelieve men het ontbrekende deel in de handleiding aan te kruisen en deze te zenden aan Gebr. FALLER GmbH, kundendienst@faller.de, Kreuzstraße 9, D-78148 Gütenbach. U ontvangt dan omgaand en gratis het ontbrekende onderdeel. Van dit bouwpakket worden enkele kunststof delen niet gebruikt.

Für den Zusammenbau des Modells empfehlen wir folgende FALLER-Artikel (sind nicht im Bausatz enthalten):
For the assembly of the kit we recommend following FALLER products (not included in the kit):
Pour l'assemblage du modèle, nous vous recommandons les articles FALLER suivants (non inclus dans le kit):
Om dit model te bouwen adviseren wij de volgende FALLER producten (maken geen deel uit van deze bouwset):



Art. Nr. 170492
FALLER-EXPERT

Flüssigkleber in Plastikflasche mit Spezialkanüle für Feinste Klebstoffdosierung.

Liquid cement in plastic bottle with canule for very fine dosage.

Colle liquide en bouteille plastique avec bec verseur pour un dosage précis.

Vloeibare lijm in plastic-flacon met doseerbuisje om nauwkeurig te lijmen.



Art. Nr. 170688
SPEZIAL-SEITENSCHNEIDER

zum gratfreien Abtrennen von feinsten Spritzteilen.
Nur für Polystyrol geeignet.

Special side cutter for cutting off ultra-fine moulded parts without burrs.
Only suitable for polystyrene.

Pince coupante spéciale pour couper sans bavure les pièces miniatures moulées par injection. Convient uniquement au polystyrène.

Speciale zijknijptang voor het braamloos afknippen van de fijnste gielstukdelen. Alleen geschikt voor polystyrol.

Montage für die Erweiterung mit Art. 194901 siehe Seite 9.
Extension with art. 194901 see on page 9.
Prolongement avec art. 194901 voir page 9.
Verlenging met art. 194901 zie blz. 9.



Inhalt	Spritzlinge	1	1 x	4	1 x	7	2 x	10	1 x	16 AB	1 x
Contents	Sprues	2	1 x	5	1 x	8	2 x	11	1 x		
Contenu	Moulages										
Inhoud	Gielstukken	3	1 x	6	1 x	9 AB	1 x	12	1 x		

Sa. Nr. 210 952 0

2

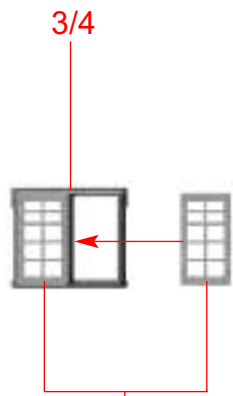

(A) 6 x 2/2

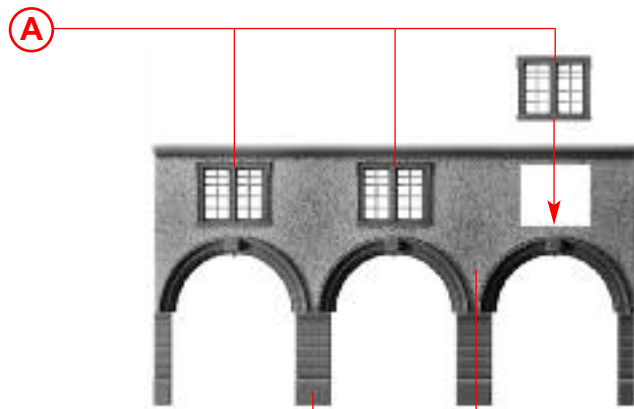

(B) 2 x 1/1 2/1

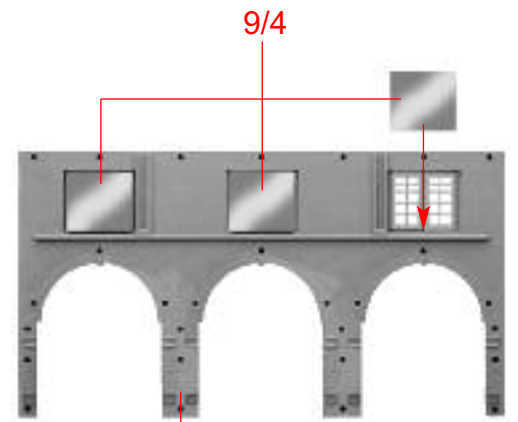

(C) 2 x **(B)**

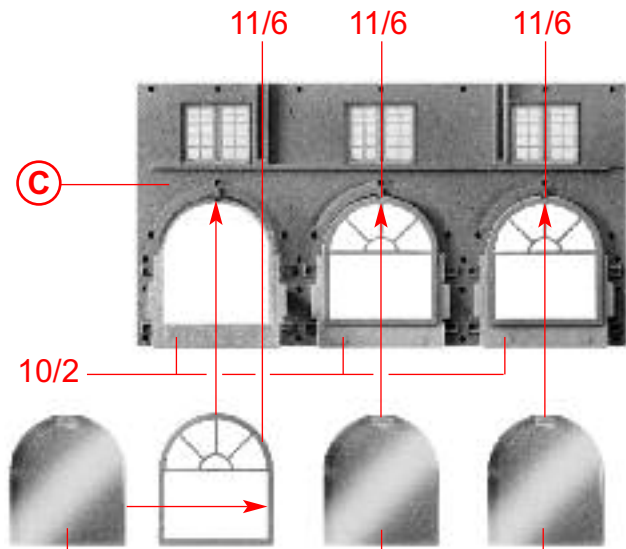

(D) 12/5

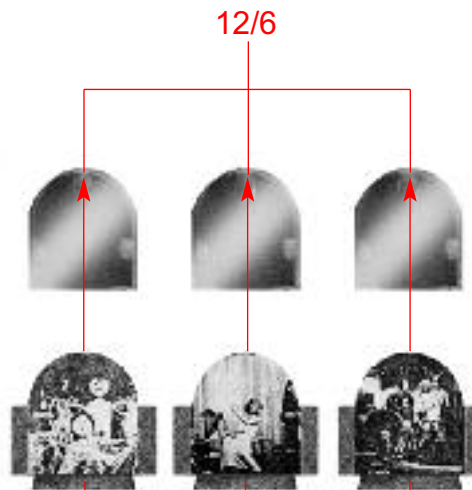

(E) Deco 1 + 2 + 3

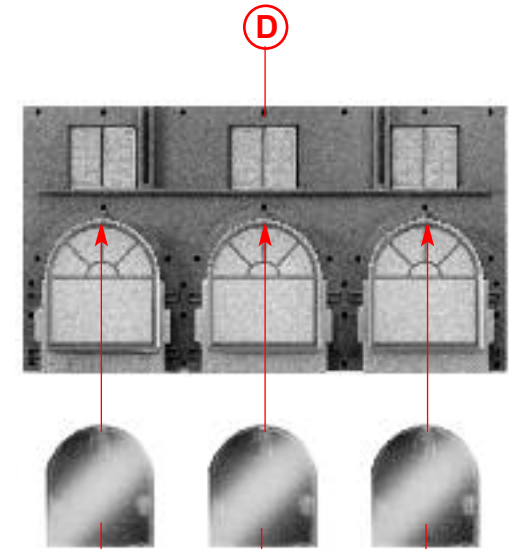

(F) **(E)**

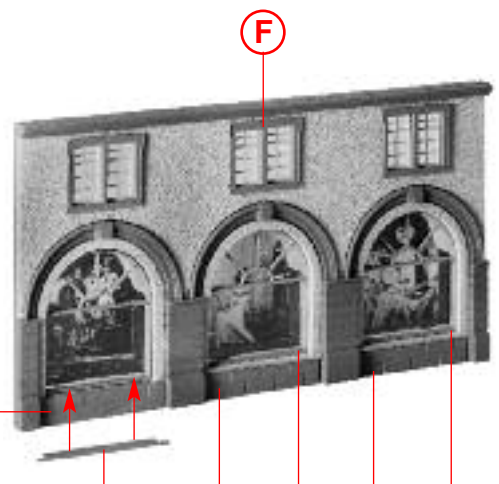

16/7

G

16/9 16/7 16/9 16/7 16/9

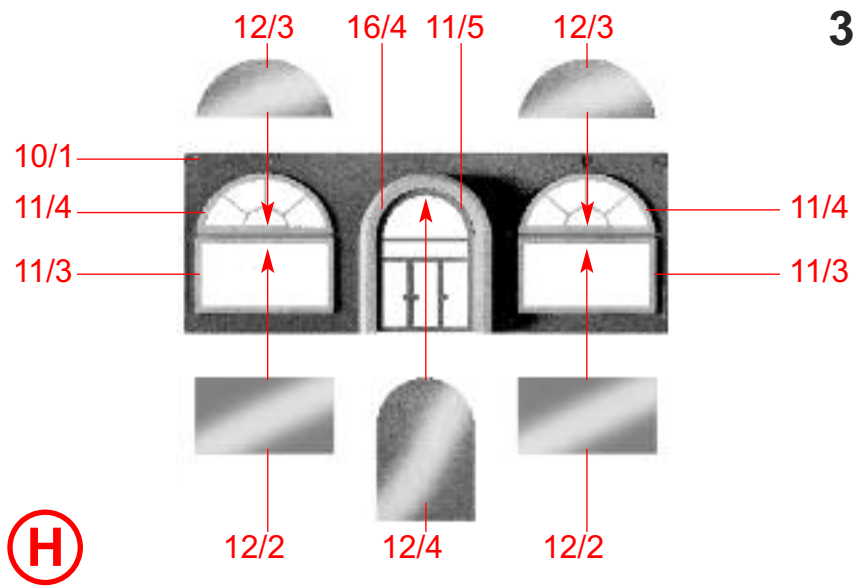

H

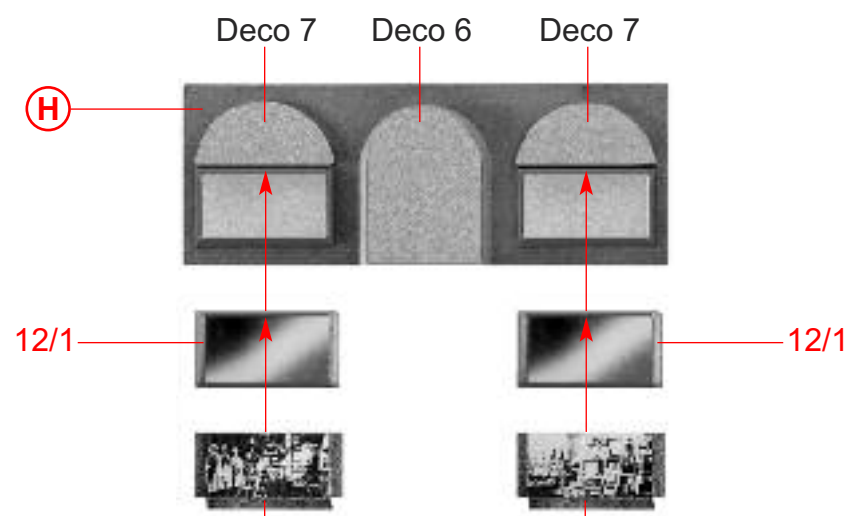

H

I

Deco 4

Deco 5

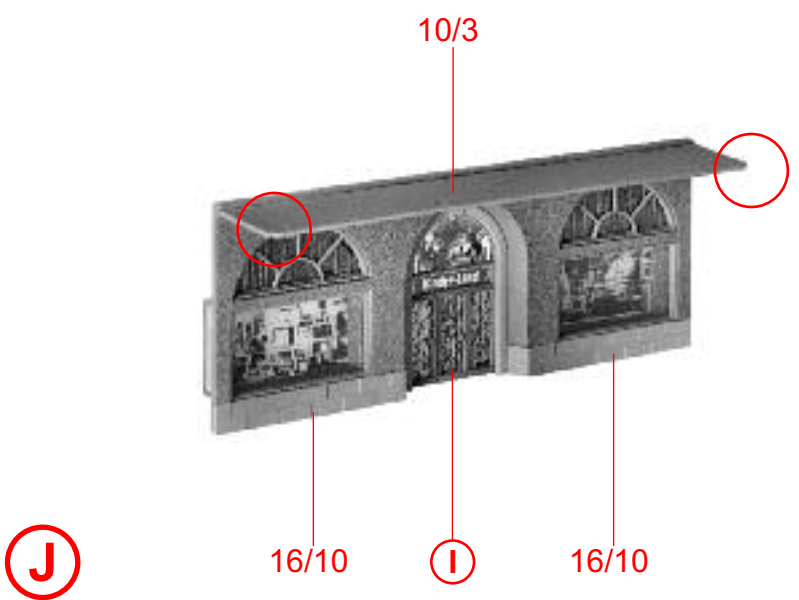

J

16/10

I

16/10

4

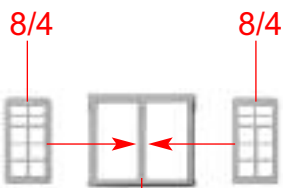

(K) 2 x 16/3

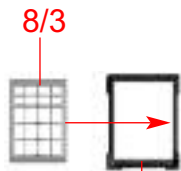

(L) 14 x 16/2

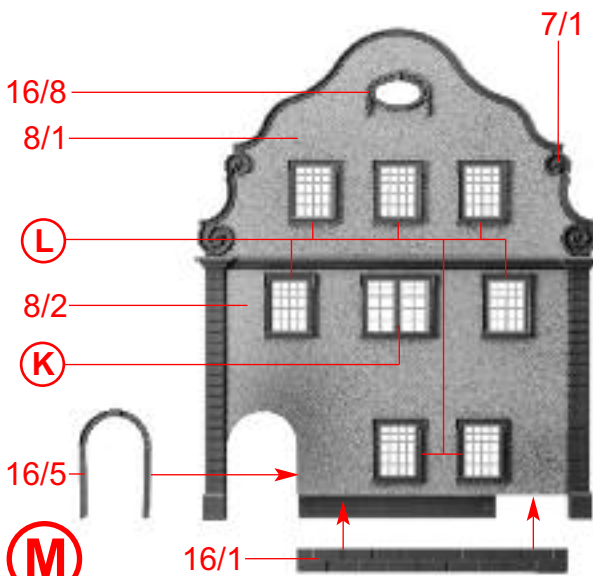

(M)

Deco 8

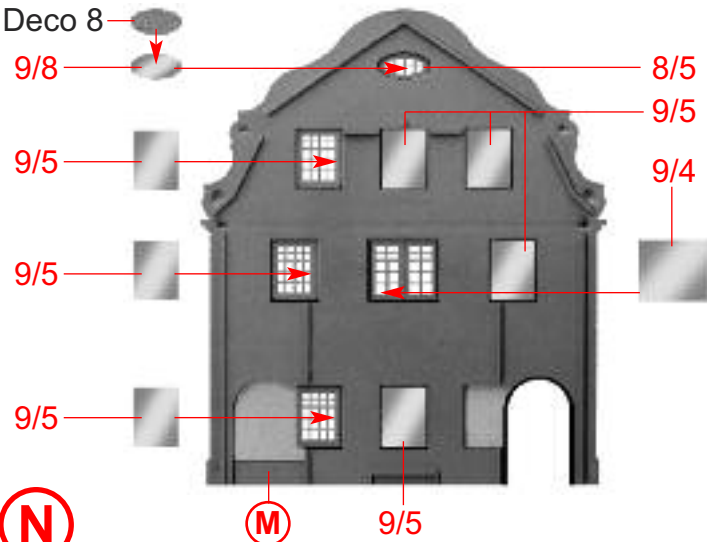

(N)

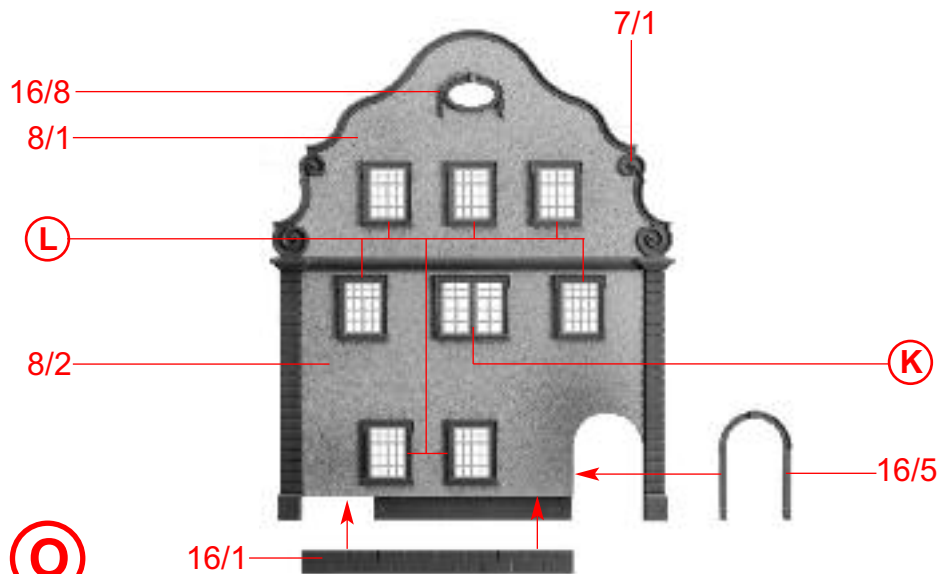

(O)

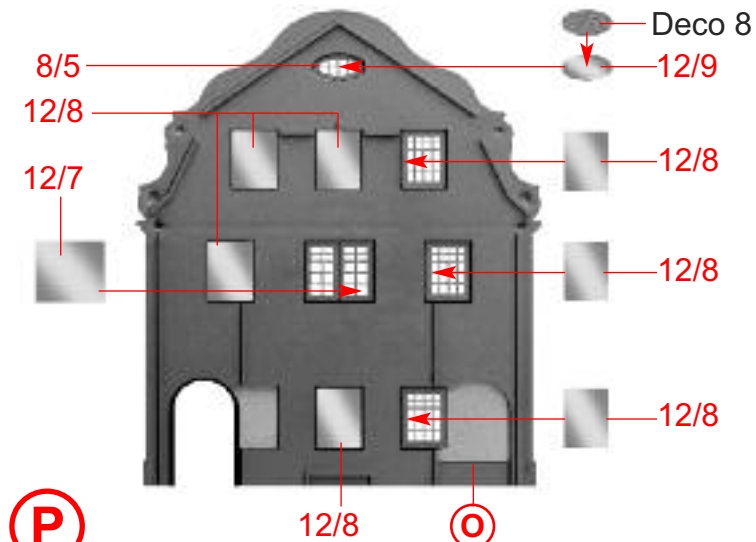

(P)



Q 6 x

3/3

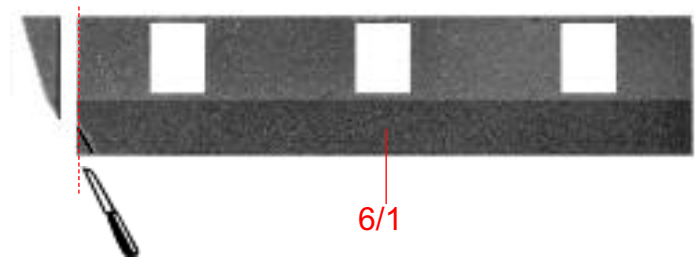

S

6/1

R

S

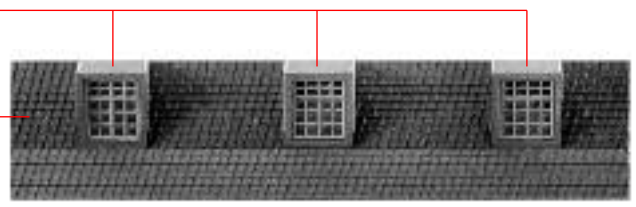

T

9/6 Deco 9

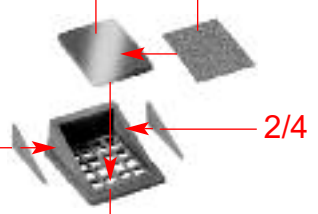

R 6 x

Q

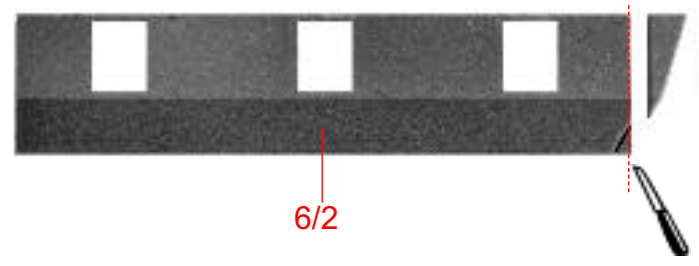

U

6/2

R

U

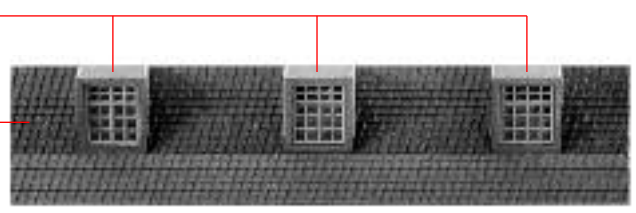

V

6

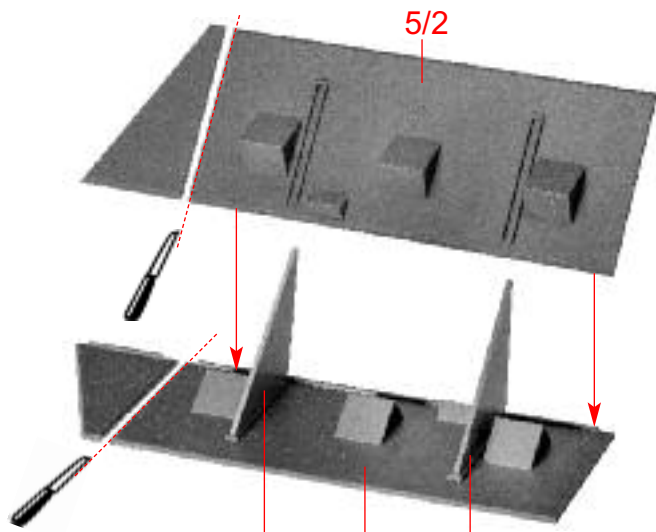

(W)

5/3 5/1 5/3

5/2

(X) 6 x

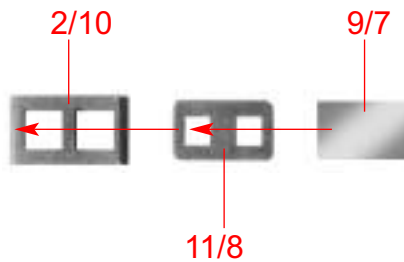

2/8

(Y) 6 x

(X)

2/9

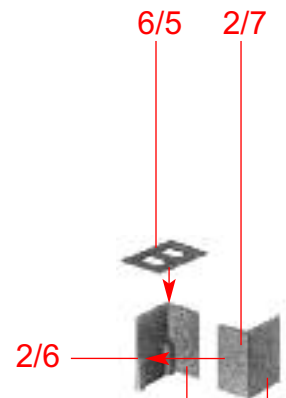
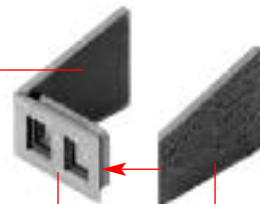

(Z) 2 x 2/7 2/6

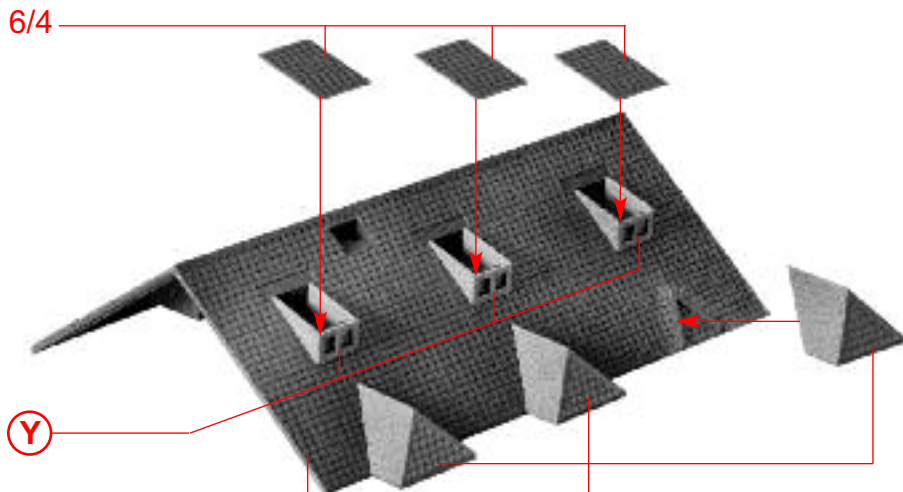

(Y)

(a)

(W)

6/3

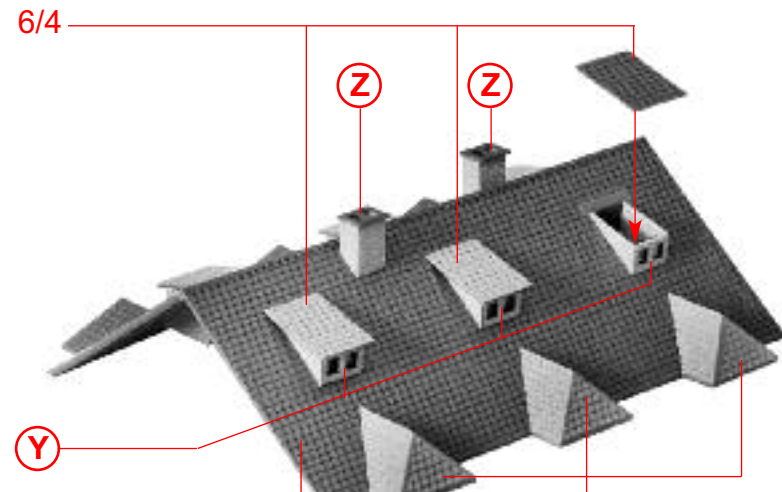

(Y)

(b)

(a)

6/3

(Z)

(Z)

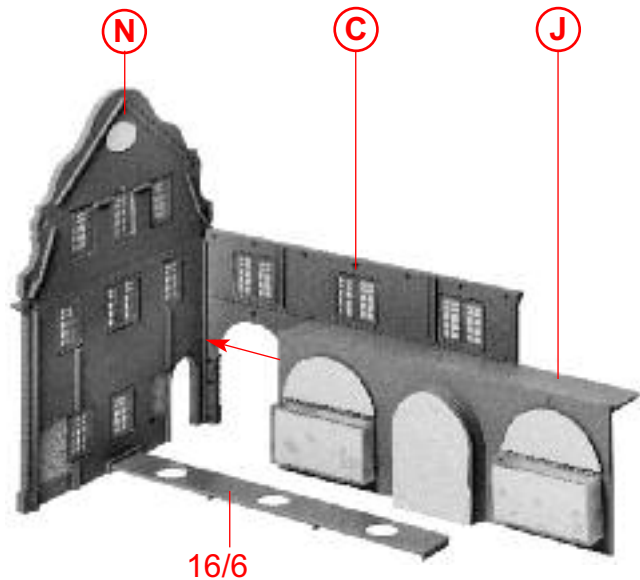

c

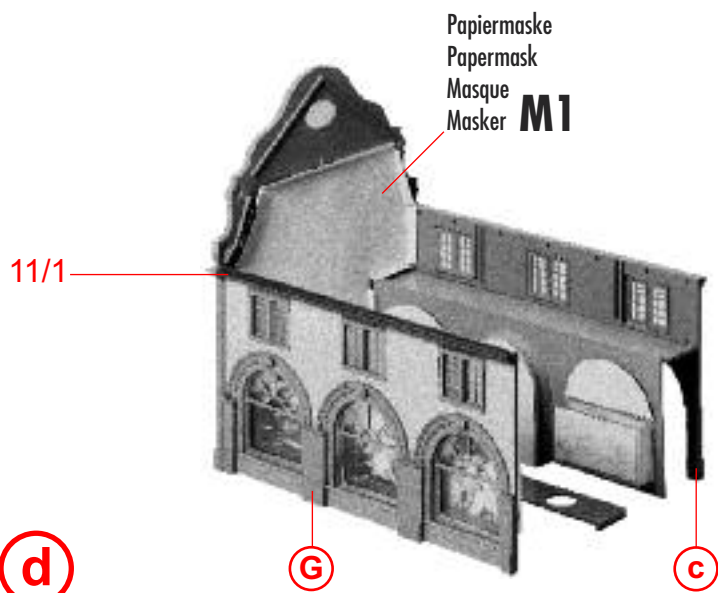

d

Papiermaske
Papermask
Masque
Masker **M1**

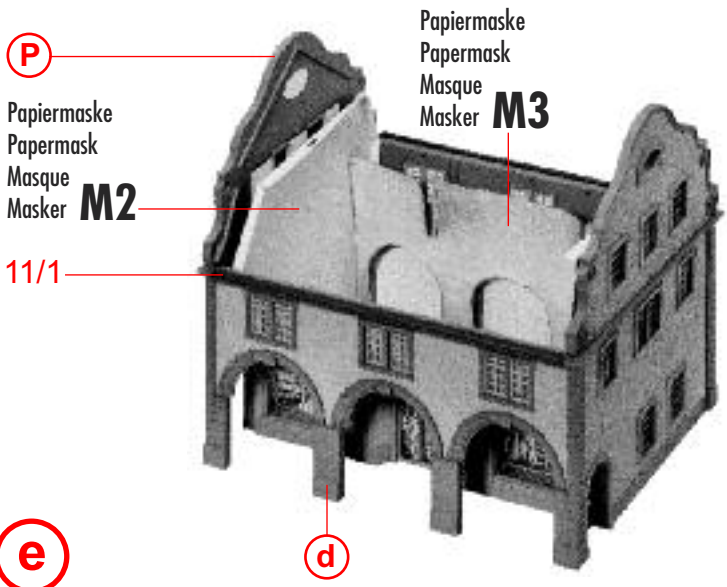

e

Papiermaske
Papermask
Masque
Masker **M3**

Papiermaske
Papermask
Masque
Masker **M2**

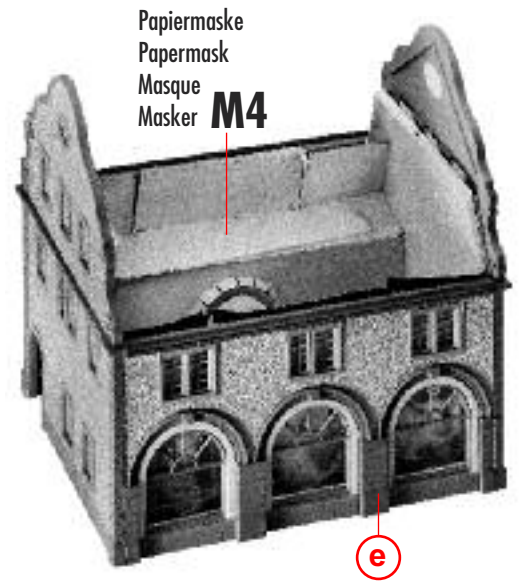

f

Papiermaske
Papermask
Masque
Masker **M4**

8

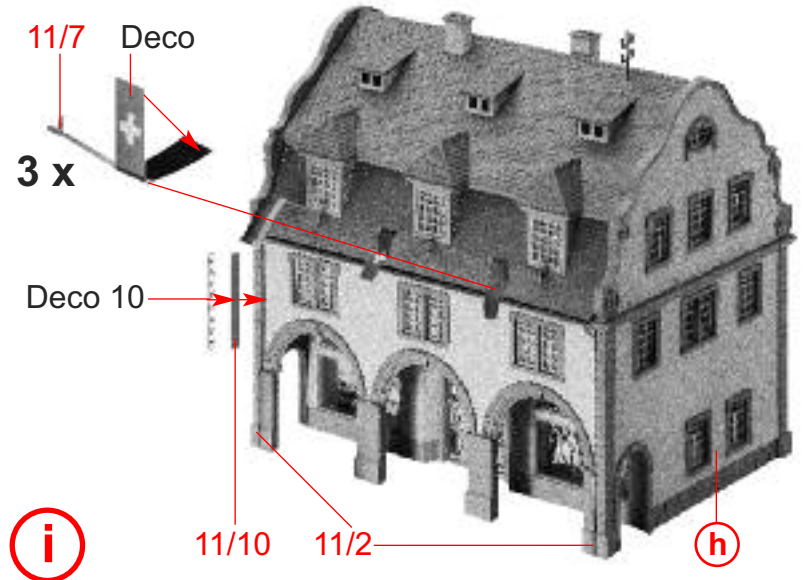
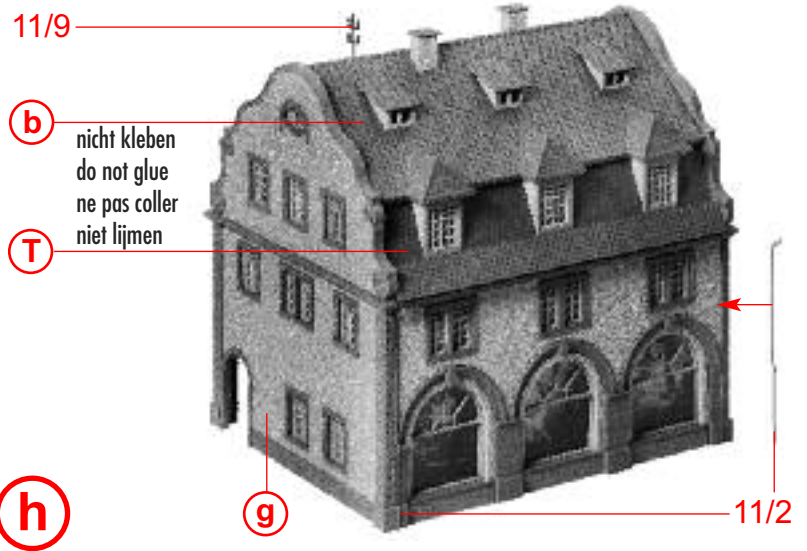
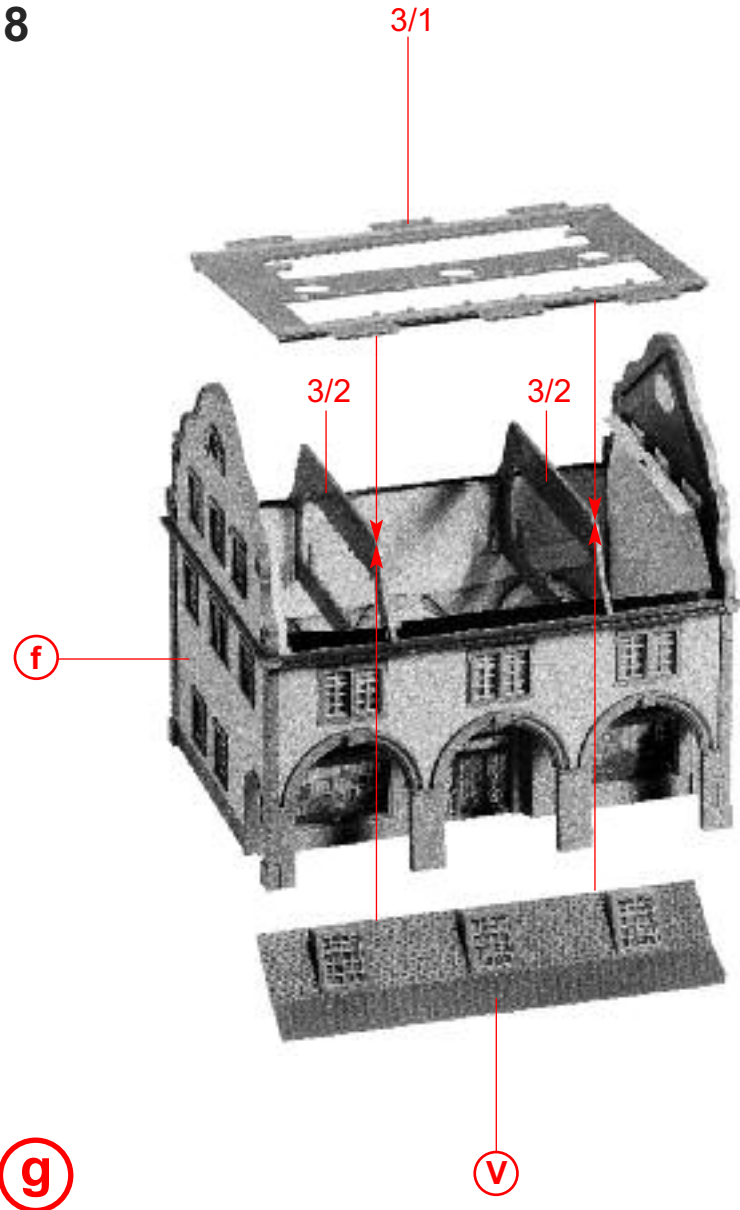

Montage für die Erweiterung mit Art. 194901.
 Extension with art. 194901.
 Prolongement avec art. 194901.
 Verlenging met art. 194901.

j 6 x

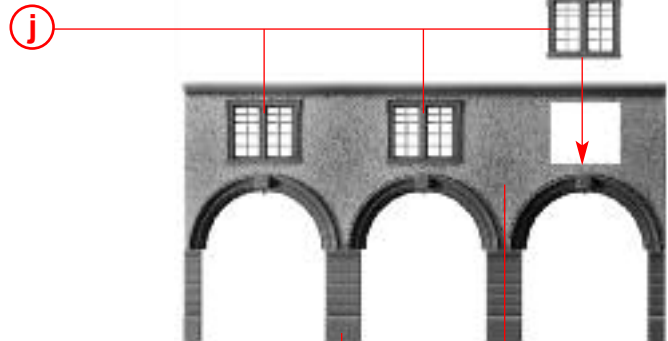
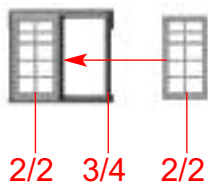

k 2 x

1/1 2/1

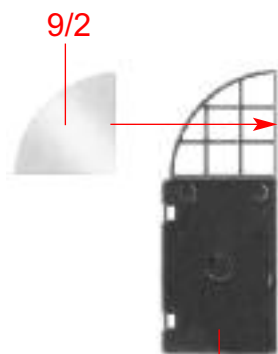

l 6 x

4/2

nicht kleben
do not glue
ne pas coller
niet lijmen

m 6 x

l

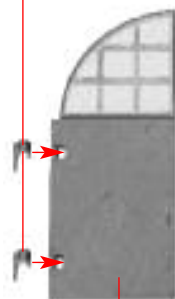

n 6 x

nicht kleben
do not glue
ne pas coller
niet lijmen

o 6 x **n**

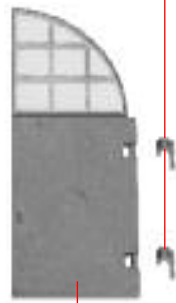

4/1

9/1

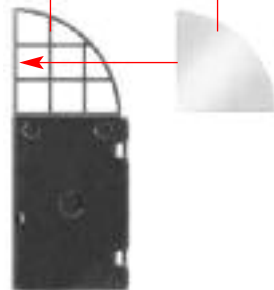

p 2 x

m **o** **m** **o** **m** **o**

Papiermaske
Papermask
Masque
Masker

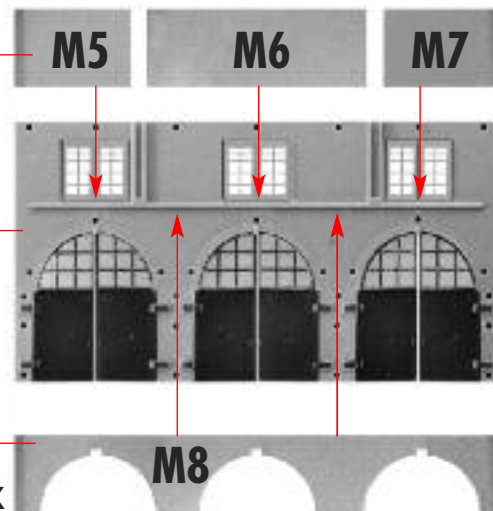

q 2 x

M8

10

3/2

q

3/2

N

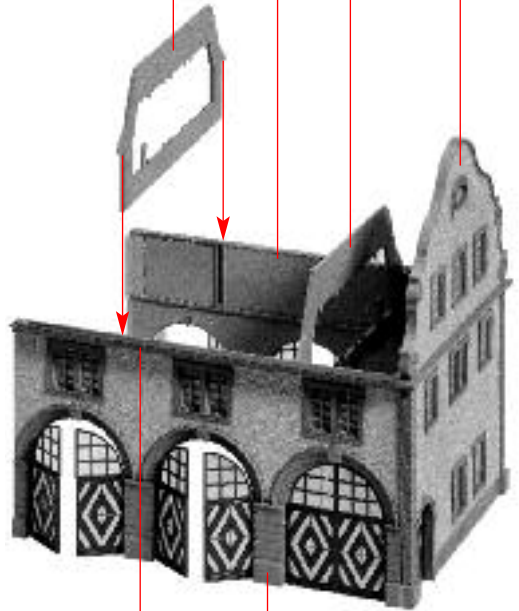

r

11/1

q

3/1

11/1

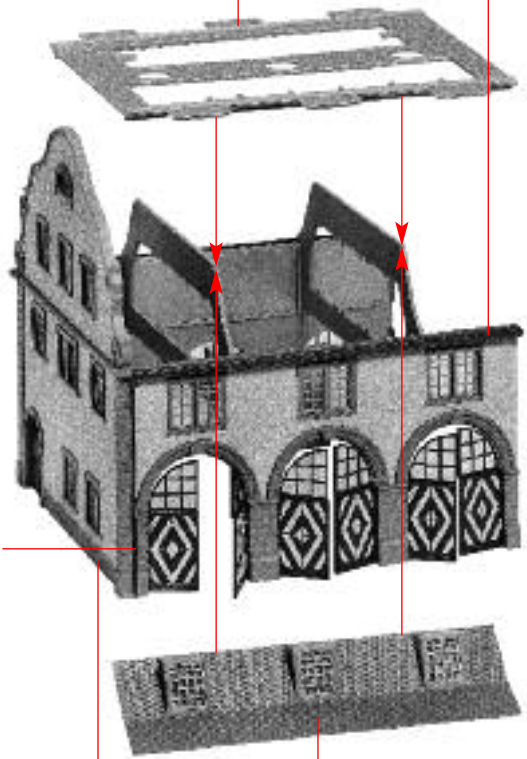

11/2

s

r

T

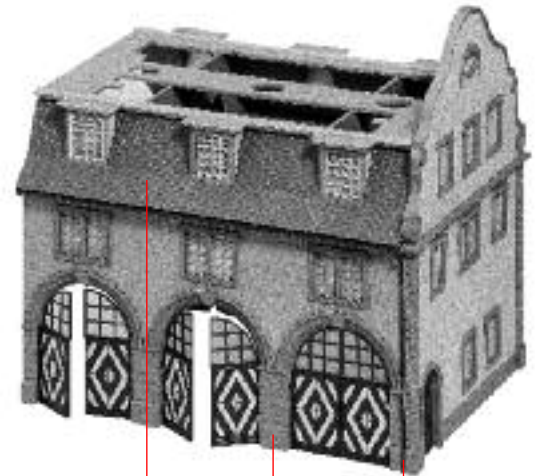

t

v

s

11/2

